

CATALOGO DE RECAMBIOS

**RANGE ROVER
DISCOVERY**

FREELANDER

**NEW RANGE ROVER
DEFENDER**



AngloreCambios
Especialistas, S.A.

CATALOGO DE RECAMBIOS

SEGUNDA EDICIÓN 2001

	INDICE	PÁGINA 2
GRUPO 1	AMORTIGUADORES	PÁGINA 3
GRUPO 2	BOMBAS DE AGUA	PÁGINA 4
GRUPO 3	BOMBAS DE COMBUSTIBLE	PÁGINA 5
GRUPO 4	BOMBAS DE VACIO / DEPRESORES	PÁGINA 5
GRUPO 5	BUJIAS Y CALENTADORES	PÁGINA 6
GRUPO 6	CORREAS	PÁGINA 7
GRUPO 7	DIRECCIÓN	PÁGINA 8 – 11
GRUPO 8	DISTRIBUCIÓN	PÁGINA 12 – 13
GRUPO 9	EMBRAGUE	PÁGINA 14 – 15
GRUPO 10	ENCENDIDO MOTOR V8	PÁGINA 16
GRUPO 11	ESCAPES	PÁGINA 17 – 18
GRUPO 12	ESCOBILLAS	PÁGINA 18
GRUPO 13	FILTROS	PÁGINA 19 – 21
GRUPO 14	FRENOS	PÁGINA 22 – 24
GRUPO 15	ILUMINACION	PÁGINA 25 – 27
GRUPO 16	JUNTAS HOMOCINETICAS	PÁGINA 28
GRUPO 17	MOTOR DE ARRANQUE	PÁGINA 28
GRUPO 18	MOTORES	PÁGINA 29 – 33
GRUPO 19	REFRIGERACION	PÁGINA 34
GRUPO 20	SILENTBLOCKS	PÁGINA 35
GRUPO 21	TRANSMISION	PÁGINA 36 – 37
	NUMEROS DE CHASIS	PÁGINA 38
	ACEITES	PÁGINA 39

GRUPO 1 : AMORTIGUADORES



DELANTEROS

		REF
DEFENDER 90 200/300 TDI	H: WA	STC3766
DEFENDER 90 TD5	D: XA	RSC100040
DEFENDER 110 200/300 TDI	H: WA	STC3769
DEFENDER 110 TD5	D: XA	RSC100050
DEFENDER 130 200/300 TDI	H: WA	STC3769
DEFENDER 130 TD5	D: XA	RSC100050
DISCOVERY 200/300 TDI		STC3703
DISCOVERY II	Sin Antibalanceo (ACE)	RNB103533
DISCOVERY II	Con Antibalanceo (ACE)	RNB103683
DISCOVERY II	Con Autonivelante (SLS) sin ACE	RNB103533
DISCOVERY II	Con Autonivelante (SLS) con ACE	RNB103694
RANGE ROVER	TODOS	STC2829
SI MONTA BARRAS ESTABILIZADORAS		STC207
NEW RANGE		STC3672
FREELANDER IZQUIERDO GASOLINA		RNB103550
FREELANDER DERECHO GASOLINA		RNB103540
FREELANDER IZQUIERDO DIESEL		RNB103570
FREELANDER DERECHO DIESEL		RNB103560

TRASEROS

		REF
DEFENDER 90 200/300 TDI	H: WA	STC3767
DEFENDER 90 TD5	D: XA	RPM100070
DEFENDER 110 200/300 TDI	H: HA478284	RTC4639
DEFENDER 110 200/300 TDI	D: HA478285	STC3771
DEFENDER 110 200/300 TDI	HEAVY DUTY	STC3772
DEFENDER 110 TD5	D: XA	RPM100080
DEFENDER 130 200/300 TDI		STC3772
DEFENDER 130 TD5	D: XA	RPM100080
DISCOVERY 200 TDI	H: LA081991	STC3939
DISCOVERY 300 TDI	D: MA081992	STC3704
DISCOVERY II	Sin Antibalanceo (ACE)	RPD102333
DISCOVERY II	Con Antibalanceo (ACE)	RPD102343
DISCOVERY II	Con Autonivelante (SLS) sin ACE / H: XA	RPD102362
DISCOVERY II	Con Autonivelante (SLS) sin ACE / D: XA	RPD102363
DISCOVERY II	Con Autonivelante (SLS) con ACE	RPD102354
RANGE ROVER	H: GA417084	STC3941
RANGE ROVER	D: GA417085	STC3939
RANGE ROVER	H: MA (con barras estabilizadoras)	STC208
RANGE ROVER	D: MA (con barras estabilizadoras)	STC2831
NEW RANGE		STC3671
FREELANDER IZQUIERDO		RPD102190
FREELANDER DERECHO		RPD102180



H: Hasta el año correspondiente. D: Desde el año correspondiente

GRUPO 2 : BOMBAS DE AGUA



BOMBAS DE AGUA

DEFENDER 200 TDI
DEFENDER 300 TDI
DEFENDER TD5

RANGE 2.4 TD VM
RANGE 2.5 TD VM

RANGE 200 TDI
RANGE 300 TDI

RANGE 3.5 CARBURACION SIN VISCOSO
RANGE 3.5 CARBURACION
MOTOR: 341, 355, 359/ SUFIJO: C, D, E, 8, 25:1 CR
RANGE 3.5 CARBURACION SIN AIRE
MOTOR: 341, 355, 359/ SUFIJO: C, D, E, 8, 25:1
RANGE 3.5 CARBURACION SIN AIRE
MOTORES: 355, 398, 11D, 13D, 15D, 16D, 17D, 19D, 20D, 21D
RANGE 3.5 CARBURACION CON AIRE D: 1970-82
RANGE 3.5 CARBURACION CON AIRE D: 1982-85

RANGE 3.5/3.9 EFI

NEW RANGE GASOLINA
NEW RANGE DIESEL BMW
NEW RANGE DIESEL BMW

H: MA303747
D: MA303748

DISCOVERY 200 TDI
DISCOVERY 300 TDI
DISCOVERY II TD5

FREELANDER GASOLINA
FREELANDER GASOLINA
FREELANDER DIESEL
FREELANDER DIESEL

4 Cilindros 1.800 cc
V6 2.500 cc
2.000cc T. CIE
TD4

REF

STC639
STC1086
ERR6505

RTC4925
RTC6666

RTC6395
STC1086

STC1611
613273

STC481
STC1610

STC486
STC482

STC483

STC4378
STC2192
STC3342

RTC6395
STC1086
ERR6505

PEB10051
PEB102240L
PEB102420L
PEB102470L

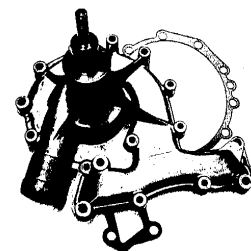

613273

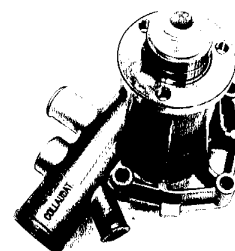

RTC4925

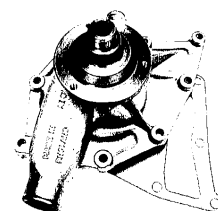

RTC6395

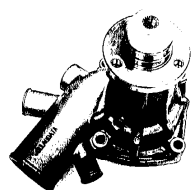

RTC6666



STC1086



STC1610



STC1611



STC2192

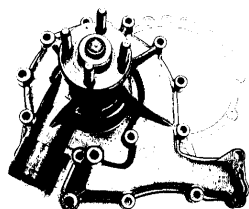

STC481

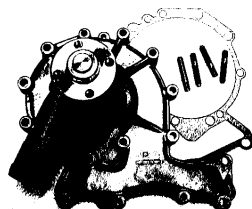

STC483

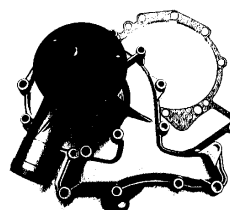

STC486

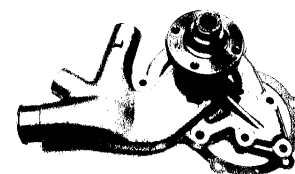

STC639

H: Hasta el año correspondiente. D: Desde el año correspondiente

GRUPO 4 : BOMBAS DE COMBUSTIBLE



BOMBAS DE COMBUSTIBLE	DIESEL	REF
RANGE ROVER 2.4 TD VM		AEU2291L
RANGE ROVER 2.5 TD VM		AEU2291L
DEFENDER 90/110 200 TDI		ETC7869
DEFENDER 90/110 300 TDI		ERR5057
DEFENDER 90 TD5		WQB100410
DEFENDER 110 TD5		WQB100420
DISCOVERY 200 TDI	(EX ETC7869)	STC1190
DISCOVERY 300 TDI		ERR5057
	GASOLINA	REF
RANGE ROVER (PRIMITIVO)	MECANICA	RTC6724
RANGE ROVER (PRE 85)	ELECTRICA HORIZONTAL	PRC3901
RANGE ROVER (PRE 85)	ELECTRICA VERTICAL	PRC3901
RANGE ROVER CARBURACION	H: GA	PRC7020
RANGE ROVER INYECCION	H: GA	PRC8318
RANGE ROVER	D: HA ; H: KA642682	PRC9409
RANGE ROVER	D: KA642683	ESR3926

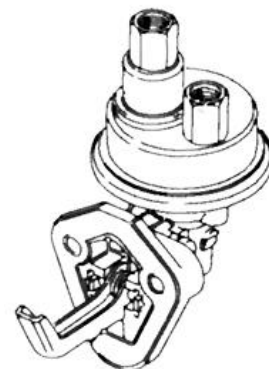

GRUPO 4 : BOMBAS DE VACIO / DEPRESORES

BOMBA DE VACIO / DEPRESORES	REF
DEFENDER 200 TDI	ERR535
DEFENDER 300 TDI	ERR3539
DISCOVERY 200 TDI	ERR535
DISCOVERY 300 TDI	ERR3539
RANGE ROVER 200 TDI	ERR535
RANGE ROVER 300 TDI	ERR3539
RANGE ROVER 2.4 VM	RTC4995
RANGE ROVER 2.5 VM	RTC6644
FREELANDER TD4	SQJ100090L



H: Hasta el año correspondiente. D: Desde el año correspondiente

GRUPO 5 : BUJIAS Y CALENTADORES



CALENTADORES

DEFENDER 90 200/300 TDI
DEFENDER 110 200/300 TDI
DEFENDER TD5

RANGE DIESEL VM
RANGE 200/300 TDI

NEW RANGE

DISCOVERY 200/300 TDI
DISCOVERY II TD5

FREELANDER
FREELANDER

2.000 T. CIE
TD4

REF

ETC8847
ETC8847
ERR6066

ERC8648
ETC8847

STC3103

ETC8847
ERR6066

NCC100050L
NCC100120L



BUJIAS

MOTOR V8

H: 1979
MOTORES: 341-355-356-357-359
SUFIJO: A,E.
1980 – 1985
D: 1986 3.5 INYECCION
N9YC 3.9 INYECCION
RN11YC 4.2 INYECCION
RN12YC VEHICULOS CON CATALIZADOR

REF

RTC3573

RTC3570
RTC3812
ERR743
ERR3799
ETC7244

FREELANDER
FREELANDER

4 Cilindros 1.800 cc
V6 2.500 cc

NLP100190
NLP100290L



H: Hasta el año correspondiente. D: Desde el año correspondiente

GRUPO 6 : CORREAS



DEFENDER 200 TDI

BOMBA DE AGUA

DIRECCION

ALTERNADOR

DEFENDER 300 TDI

BOMBA DE AGUA

BOMBA DE AGUA

AIRE ACONDICIONADO

DEFENDER TD5

ALTERNADOR

ALTERNADOR

RANGE V8

BOMBA DE AGUA

DIRECCION

AIRE ACONDICIONADO

ALTERNADOR

RANGE 2.4 TD VM

BOMBA DE AGUA

DIRECCION

AIRE ACONDICIONADO

ALTERNADOR

RANGE 2.5 TD VM

BOMBA DE AGUA

DIRECCION

AIRE ACONDICIONADO

NEW RANGE

GASOLINA V8 CON AIRE ACONDICIONADO H: WA410481

GASOLINA V8 CON AIRE ACONDICIONADO D: XA410482

GASOLINA V8 SIN AIRE ACONDICIONADO H: WA410481

GASOLINA V8 SIN AIRE ACONDICIONADO D: XA410482

ALTERNADOR DIESEL

AIRE ACONDICIONADO DIESEL

DISCOVERY 200 TDI

BOMBA DE AGUA

DIRECCION

AIRE ACONDICIONADO

ALTERNADOR

DISCOVERY 300 TDI

CORREA DE MANDO

CORREA DE MANDO

AIRE ACONDICIONADO

DISCOVERY II TD5

ALTERNADOR

ALTERNADOR

ALTERNADOR

ALTERNADOR

FREELANDER

ALTERNADOR DIESEL T. CIE.

ALTERNADOR DIESEL T. CIE.

BOMBA INYECTORA DIESEL T. CIE.

ALTERNADOR GASOLINA 4 cil 1.800 cc

ALTERNADOR GASOLINA 4 cil 1.800 cc

DIRECCION GASOLINA 4 cil 1.800 cc

ALTERNADOR GASOLINA V6 2.500 cc

ALTERNADOR GASOLINA V6 2.500 cc

COMPRESOR AIRE V6 2.500 cc

ALTERNADOR / DIRECCION TD4

AIRE ACONDICIONADO TD4

7PK1595

7PK1580

CON AIRE ACONDICIONADO

SIN AIRE ACONDICIONADO

H: MA163103

D: TA163104

Con ACC y conAntibalanceo (ACE)

Sin ACC y con Antibalanceo (ACE)

Con ACC y sin Antibalanceo (ACE)

Sin ACC y sin Antibalanceo (ACE)

Sin Aire Acondicionado

Con Aire Acondicionado

Sin Aire Acondicionado

Con Aire Acondicionado

Sin Aire Acondicionado

Con Aire Acondicionado

REF

ETC7939

ETC5815

ETC7939

REF

ERR3287

ERR5911

ERR2215

REF

PQS101500

PQS101490

REF

611612

ERC675

611612

ERR2073

REF

ETC9019

ETC9080

ETC9009

ETC9019

REF

ERR914

ETC9101

ETC9009

REF

ERR4460

PQS101480

ERR4461

PQS101470

STC4455

STC3397

REF

ERR810

ERR810

ETC9009

ETC7469

REF

ERR3287

ERR5911

ERR2215

REF

PQS101510

PQS101520

PQS101500

PQS101490

REF

PQS101030

PQS100850

MVF100040

PQS100840

PQS101130

CDU2160

PQS101261L

PQS101271L

PQS101300L

PQS101310L

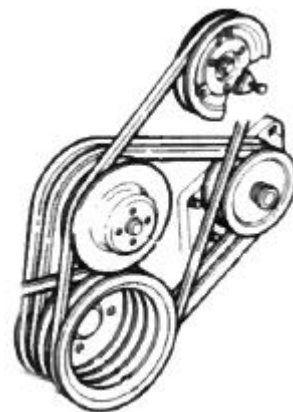

H: Hasta el año correspondiente. D: Desde el año correspondiente

GRUPO 7 : DIRECCION



ROTULA DE DIRECCION

		REF
DEFENDER 90/110 (DESPIECE)		STC3295
DEFENDER 90/110	X2 LADO DERECHO	RTC5869
DEFENDER 90/110	X1 LADO IZQUIERDO	RTC5870
DISCOVERY 200/300 TDI (DESPIECE)		STC3295
DISCOVERY 200/300 TDI	X2 LADO DERECHO	RTC5869G
DISCOVERY 200/300 TDI	X1 LADO IZQUIERDO	RTC5870
DISCOVERY II TD5	ROTULA BIELETA DIRECCION (+ BARRA)	QEK100130
DISCOVERY II TD5	X2 LADO DERECHO	QFS100060
DISCOVERY II TD5	X1 LADO IZQUIERDO	QFS000040
RANGE ROVER (DESPIECE)		STC3295
RANGE ROVER	X2 LADO DERECHO	RTC5869
RANGE ROVER	X1 LADO IZQUIERDO	RTC5870
NEW RANGE ROVER	ROTULA BIELETA DIRECCION (+ BARRA)	STC1872
NEW RANGE ROVER	X2 LADO DERECHO	STC1871
NEW RANGE ROVER	X1 LADO IZQUIERDO (+ BARRA)	STC1870
FREELANDER LADO IZQUIERDO		QJB100220
FREELANDER LADO DERECHO		QJB100230

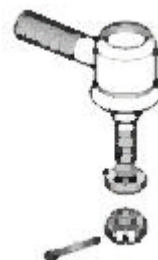

BARRA PANHARD

		REF
DEFENDER 90/110		RBI100000
RANGE ROVER	H: 1985	575501
RANGE ROVER	D: 1985	RBI100000
DISCOVERY		RBI100000
NEW RANGE		ANR3665
FREELANDER		NO PROCEDE



H: Hasta el año correspondiente. D: Desde el año correspondiente

GRUPO 7 : DIRECCION



CAJA DE DIRECCIÓN

		REF
DEFENDER 90/110 TDI JUEGO DE REPARACION RETENES	GEMMER H: JA919038 (TAPA 6 TORNILLOS CIRCULAR)	NTC1583 RTC5071
DEFENDER 90/110 TDI JUEGO COMPLETO DE REPARACION JUEGO RETENES INFERIOR SECTOR	ADWEST D: JA919039 (TAPA 4 TORNILLOS CUADRADA)	STC2845 STC2847 STC2848
DISCOVERY		STC2845
DISCOVERY II JUEGO DE REPARACION 1 JUEGO DE REPARACION 2 JUEGO DE REPARACION 3 JUEGO DE REPARACION 4		QAF100150 QFW100190 QFW100150 QFW100180 QFW100140
RANGE ROVER CLASSIC		STC2845
NEW RANGE ROVER		ANR5321
FREELANDER	(CONJUNTO CREMALLERA)	QAB102364

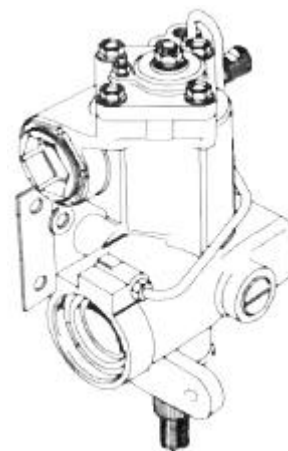

LATIGUILLOS Y TUBERÍAS

BOMBA DE DIRECCIÓN A CAJA DE DIRECCIÓN

DEFENDER 90/110 200 TDI	D: HA455945 H: JA918809	NTC8191
DEFENDER 90/110 200 TDI	D: JA918810 H: LA939975	NTC9074
DEFENDER 90/110 300 TDI	D: MA939976	ANR2136
DISCOVERY 200 TDI		NTC6070
DISCOVERY 300 TDI		ANR6656
DISCOVERY II TD5		QEP105490
DISCOVERY II GASOLINA		QEP105480
RANGE ROVER CLASSIC	DIESEL H: MOTOR Nº 11 A33463	NTC3088
RANGE ROVER CLASSIC	DIESEL D: MOTOR Nº 11 A33464 (VM)	NTC6732
RANGE ROVER CLASSIC	DIESEL TDI	NTC6070
RANGE ROVER CLASSIC	GASOLINA D: CA H: HA610293 (PARA BOMBA DE DIRECCIÓN ETC5869)	NTC1368
RANGE ROVER CLASSIC	GASOLINA D:CA H: MA...FIN DE SERIE (PARA BOMBA DE DIRECCIÓN ANR2003)	NTC6790
RANGE ROVER CLASSIC	SUSPENSIÓN NEUMÁTICA	CONSULTAR
NEW RANGE ROVER	DIESEL	ANR4331
NEW RANGE ROVER	GASOLINA H: WA410481	ANR3856
NEW RANGE ROVER	GASOLINA D: XA410482	QEP104910
FREELANDER		CONSULTAR



H: Hasta el año correspondiente. D: Desde el año correspondiente

GRUPO 7 : DIRECCION



CAJA DE DIRECCIÓN A DEPÓSITO LÍQUIDO

DEFENDER 90 200 TDI	D: 244023 H: JA918809	NTC1863
DEFENDER 90 200 TDI	D: JA918810 H: LA939975	NTC8866
DEFENDER 90 300 TDI	D: MA939976	ANR2487
DEFENDER 110 200 TDI	H: JA918809	NTC8860
DEFENDER 110 200 TDI	D: JA918810 H: LA939975	ANR2487
DEFENDER 110 300 TDI	D: MA	ANR2487
DISCOVERY 200 TDI	H: HA486551	NTC6072
DISCOVERY 200 TDI	H: LA081991	NTC8864
DISCOVERY 300 TDI	D: MA081992	ANR3783
DISCOVERY II TD5		QEP105500
DISCOVERY II GASOLINA		QEP105510
RANGE ROVER CLASSIC	DIESEL H: GA	NTC3293
RANGE ROVER CLASSIC	DIESEL D: GA	NTC7479
RANGE ROVER CLASSIC	DIESEL VM D: HA608008	NTC8866
RANGE ROVER CLASSIC	DIESEL 200 TDI H: LA647644	NTC9429
RANGE ROVER CLASSIC	DIESEL 300 TDI D: MA647645	QEH104210
RANGE ROVER CLASSIC	GASOLINA D: CA H: HA610293	NTC8862
RANGE ROVER CLASSIC	GASOLINA H: LA647644	NTC9429
RANGE ROVER CLASSIC	GASOLINA D: MA647645	QEH102370
NEW RANGE ROVER	DIESEL H: TA317511	ANR3384
NEW RANGE ROVER	DIESEL D: WA383839	ANR6752
NEW RANGE ROVER	GASOLINA H: TA317511	ANR3384
NEW RANGE ROVER	GASOLINA D: XA410482	QEP105990
FREELANDER		CONSULTAR



TUBERIA PROPIA CAJA A JAJA

DEFENDER 90/110	PARA CAJA ADWEST STC2845	RTC4401
DISCOVERY 200/300 TDI	PARA CAJA ADWEST STC2845	RTC4401
DISCOVERY II		QEP105400
RANGE ROVER CLASSIC	PARA CAJA ADWEST STC2845	RTC4401
NEW RANGE ROVER		NP
FREELANDER		CONSULTAR



H: Hasta el año correspondiente. D: Desde el año correspondiente

GRUPO 7 : DIRECCION



BOMBA DE DIRECCION

DEFENDER 90/110 200 TDI
 DEFENDER 90/110 200 TDI
 DEFENDER 90/110 300 TDI
 DEFENDER 90/110 TD5

H: 11L22454A
 D: 11L22455A

REF
 NTC8287
 NTC9070
 ANR2157
 QVB101350



RANGE ROVER V8
 RANGE ROVER 2.4 VM
 RANGE ROVER 2.4 VM
 RANGE ROVER 2.5 TD VM
 RANGE ROVER 200 TDI
 RANGE ROVER 300 TDI

H: 11A33463
 D: 11A33464

ANR2003
 ETC9081
 NTC8289
 NTC8289
 NTC8288
 ANR2157



NEW RANGE GASOLINA
 NEW RANGE GASOLINA
 NEW RANGE DIESEL

H: WA410481
 D: XA410482

QVB101090
 QVB101300
 ERR4911

DISCOVERY 200 TDI
 DISCOVERY 300 TDI

NTC8288
 ANR2157

NTC8287

DISCOVERY II
 DISCOVERY II

TD5
 GASOLINA

QVB101240
 ERR6447

FREELANDER GASOLINA
 FREELANDER GASOLINA
 FREELANDER DIESEL (T.CIE)
 FREELANDER DIESEL (T.CIE)
 FREELANDER TD4

4 CIL 1.8 cc
 V6
 CON AIRE ACONDICIONADO
 SIN AIRE ACONDICIONADO

ANR5582
 QVB101471
 QVB101070
 QVB101050
 QVB101452



AMORTIGUADOR DE DIRECCION

DEFENDER

REF
 RTC4472

RANGE ROVER

STC786

DISCOVERY

STC786

DISCOVERY II

QHH100001

NEW RANGE ROVER

ANR2640

NTC8289



NTC9070



H: Hasta el año correspondiente. D: Desde el año correspondiente

GRUPO 8 : DISTRIBUCION



CORREA/CADENA DE DISTRIBUCIÓN

DEFENDER 200 TDI
DEFENDER 300 TDI
DEFENDER TD5 (CADENA KIT)

REF
ETC8550
ERR1092
LXB100090

RANGE ROVER 200 TDI
RANGE ROVER 300 TDI

ETC8550
ERR1092

DISCOVERY 200 TDI
DISCOVERY 300 TDI

ETC8550
ERR1092

DISCOVERY II TD5 (CADENA KIT)

LXB100090

FREELANDER T.CIE
FREELANDER TD4 (CADENA INFERIOR)
FREELANDER TD4 (CADENA SUPERIOR)
FREELANDER GASOLINA 1.800cc
FREELANDER GASOLINA 1.800cc
FREELANDER GASOLINA V6
FREELANDER GASOLINA V6

SIN TENSOR AUTOMATICO
CON TENSOR AUTOMATICO
DELANTERA
TRASERA

LHN100760
MVF100040L
LHN100840L
LHN100390
LHN100560
LHN100410L
LHN100420L



TENSOR

DEFENDER 200 TDI
DEFENDER 300 TDI
DEFENDER 300 TDI

D: VA117354

REF
ERR2530
ERR1972
LHP100860

RANGE ROVER 200 TDI
RANGE ROVER 300 TDI

ERR2530
ERR1972

DISCOVERY 200 TDI
DISCOVERY 300 TDI
DISCOVERY 300 TDI

D: VA560898

ERR2530
ERR1972
LHP100860

FREELANDER T.CIE
FREELANDER TD4
FREELANDER GASOLINA 1.800cc
FREELANDER GASOLINA 1.800cc

SIN TENSOR AUTOMATICO
CON TENSOR AUTOMATICO

LHP100840
PQG100320L
LHP10015L
LHP100900L



PIÑÓN TENSOR DE DISTRIBUCION

DEFENDER 300 TDI
DEFENDER 300 TDI

D: VA117354

REF
ETC8560
LHV100150

RANGE ROVER 200 Y 300 TDI

ETC8560

DISCOVERY 200 Y 300 TDI
DISCOVERY 300 TDI

D: VA560898

ETC8560
LHV100150

FREELANDER DIESEL T.CIE
FREELANDER DIESEL TD4

LHV100160
CONSULTAR



H: Hasta el año correspondiente. D: Desde el año correspondiente

GRUPO 8 : DISTRIBUCION



CADENA DE DISTRIBUCIÓN

RANGE ROVER V8

REF

ERC7929

NEW RANGE GASOLINA
NEW RANGE DIESEL

ERC7929
STC3359

PIÑONES

REF

RANGE V8 /ARBOL DE LEVAS
RANGE V8 /CIGÜEÑAL

610289
ERR2958

NEW RANGE GASOLINA /ARBOL LEVAS
NEW RANGE GASOLINA /CIGÜEÑAL
NEW RANGE DIESEL /ARBOL DE LEVAS
NEW RANGE DIESEL /BOMBA INYECTORA
NEW RANGE DIESEL /CIGÜEÑAL

ERR5086
ERR2958
STC2143
STC3339
STC2091



KITS DE DISTRIBUCIÓN

(CORREA+TENSOR+JUNTAS+RETENES)

MOTOR

REF

200 TDI DEFENDER
200 TDI DISCOVERY/RANGE ROVER
300 TDI DISCOVERY/RANGE/DEFENDER
300 TDI D: VA DISCOVERY/DEFENDER

ANGKITDEF2
ANGKITDIR2
ANGKITD3
ANGKITDDVA3



H: Hasta el año correspondiente. D: Desde el año correspondiente

GRUPO 9 : EMBRAGUE



MAZA

DEFENDER 200/300 TDI
DEFENDER TD5

RANGE 3.5 4 Y 5 VELOCIDADES
RANGE 3.9 EFI
RANGE 3.9 EFI
RANGE 2.4 TD VM
RANGE 2.5 TD VM

NEW RANGE V8 (KIT MAZA + DISCO)
NEW RANGE DIESEL
NEW RANGE DIESEL (KIT MAZA+DISCO)

DISCOVERY 200/300 TDI

DISCOVERY II TD5

FREELANDER GASOLINA 1.8cc
FREELANDER T.CIE
FREELANDER 1.800cc
FREELANDER T.CIE
FREELANDER T.CIE
FREELANDER TD4
FREELANDER V6

(KIT EMBRAGUE)
(KIT EMBRAGUE)

H: 18N0066716 H: 17N0014188
D: 17N0014189 D: 18N0066717

REF

URB100760
FTC4630

576476
FTC813
FTC4828
URB100760
URB100760

STC50511
FTC2157
STC50512

URB100760

FTC4630

STC4613
STC4613
URB10035
URB10035
URB000070
STC4562
CONSULTAR

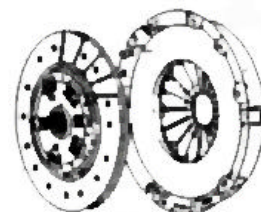

DISCO

DEFENDER 90/110 200 TDI
DEFENDER 90/110 300 TDI
DEFENDER 90/110 300 TDI
DEFENDER 130 200/300 TDI
DEFENDER TD5

RANGE 3.5 4 VELOCIDADES
RANGE 3.5 5 VELOCIDADES
RANGE 3.9 EFI
RANGE 3.9 EFI
RANGE 2.4 TD VM
RANGE 2.5 TD VM
RANGE 200 TDI
RANGE 300 TDI

NEW RANGE V8 (KIT MAZA + DISCO)
NEW RANGE DIESEL

DISCOVERY 200 TDI
DISCOVERY 200 TDI
DISCOVERY 300 TDI

DISCOEVRY II TD5

FREELANDER 1.8cc
FREELANDER V6
FREELANDER DIESEL
FREELANDER DIESEL T.CIE
FREELANDER DIESEL TD4
FREELANDER DIESEL TD4

D: 17N0014489 D: 18N0066717
H: YA999999
D: YA999999

REF

FTC2149 / FTC4204
FTC2149 / FTC4204
FTC4204
FTC1994
FTC4631

FRC9773
FTC3197
FTC814
FTC2002
FTC148
FTC2149
FTC2149
FTC4204

STC50511
FTC4488

FTC2149
FTC4204
FTC4204

FTC4631

UQB100941
CONSULTAR
UQB100690
UQB000040
STC4563
UQB101070

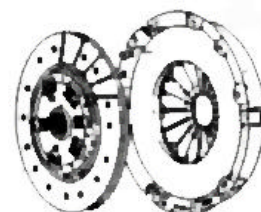
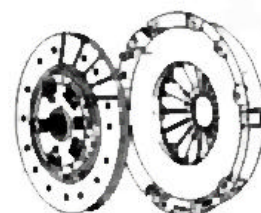

H: Hasta el año correspondiente. D: Desde el año correspondiente

GRUPO 9 : EMBRAGUE



COLLARIN

	REF
DEFENDER 200/300 TDI	FRC9568
DEFENDER 200/300 TDI	FTC5200
DEFENDER TD5	FTC5200
RANGE CLASSIC TODOS LOS MODELOS	FTC5200
NEW RANGE GASOLINA Y DIESEL	INCLUIDO EN MAZA
DISCOVERY 200/300 TDI	FTC5200
DISCOVERY 200/300 TDI	FTC5200
DISCOVERY II TD5	FTC5200
FREELANDER 1.800cc / T.CIE	UTJ100170



CILINDRO MAESTRO

	REF
DEFENDER 200/300	550732
DEFENDER TD5	STC100410
JUEGO DE REPARACION	8G8837L
RANGE ROVER	AEU1714
RANGE ROVER 300 TDI	ANR2651
JUEGO DE REPARACION	STC1126
NEW RANGE GASOLINA/DIESEL	ANR3894
JUEGO DE REPARACION	TEMPORALMENTE ANULADO
DISCOVERY 200 TDI	AEU1714
DISCOVERY 300 TDI	ANR2651
JUEGO DE REPARACION	STC1126
FREELANDER 1.8cc / T.CIE	STC100211
FREELANDER TD4	STC000170

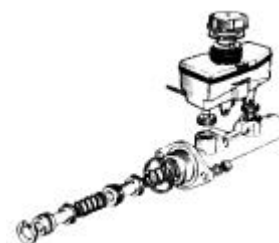

CILINDRO ESCLAVO

	REF
DEFENDER 90/110 200 TDI	591231
JUEGO DE REPARACION	8G8600L
DEFENDER 90/110 300 TDI	FTC5072
JUEGO DE REPARACION	STC2818
DEFENDER 90/110 TD5	FTC5202
JUEGO DE REPARACION	STC2818
RANGE ROVER	TKC2786L
JUEGO DE REPARACION	514244
RANGE ROVER	FTC2498
RANGE ROVER 300 TDI	FTC5072
JUEGO DE REPARACION	STC2818
NEW RANGE GASOLINA/DIESEL	ANR2967
JUEGO DE REPARACION	STC2818
DISCOVERY 200 TDI	H: KA045958
JUEGO DE REPARACION	TKC2786L
DISCOVERY 200 TDI	514244
JUEGO DE REPARACION	FTC2498
DISCOVERY 300 TDI	D: KA045959
JUEGO DE REPARACION	514244
DISCOVERY II TD5	D: MA
JUEGO DE REPARACION	FTC5072
	STC2818
DISCOVERY II TD5	FTC5200
JUEGO DE REPARACION	STC2818



H: Hasta el año correspondiente. D: Desde el año correspondiente

GRUPO 10 : ENCENDIDO MOTOR V8



ENCENDIDO MOTOR V8

REF

RANGE ROVER 3.5 CARBURACION

AMPLIFICADOR

STC1184

BOBINA

RTC5628

BUJIAS

H: 1979
MOTORES: 341-355-356-357-359
SUFIJO: A,E.
1980 - 1985
D: 1986

RTC3573

RTC3570

RTC3812

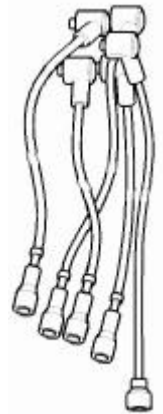

CABLES DE BUJIAS (JUEGO)

RTC6551

CONDENSADOR

RTC3472

DEPRESOR / AVANCE

MOTORES 15D-16D-17D SUF.: B
MOTORES 13D-18D SUF.: B
(SOLO ENCENDIDO ELECTRONICO)
MOTORES 13D-18D SUF.: F

608266

RTC3201

608194



PLATINOS

TODOS LOS DEMAS
MOTORES 11D-15D-16D-17D-19D SUF.: A
(DESLIZANTES)

RTC6623

RTC6626

ROTOR / PIPA

TODOS LOS DEMAS
MOTORES 11D-15D-16D-17D-19D SUF.: A
(DESLIZANTES)
(CON ENCENDIDO ELECTRONICO)

RTC6630

RTC3618

STC1857



TAPA DEL DISTRIBUIDOR

STC8368



H: Hasta el año correspondiente. D: Desde el año correspondiente

GRUPO 11 : ESCAPES



NOTA: Vehículos con catalizador consultar a parte.

ESCAPES

		SILENCIOSO INTERMEDIO	SILENCIOSO TRASERO
DEFENDER 90 200 TDI		ESR358	ESR254
DEFENDER 90 300 TDI	H: TA999221	ESR2381	
	D: VA999222	ESR4526	
	H: MA951235		ESR2382
	H: TA999221		ESR3463
	H: WA159806		ESR4527
	D: XA159807		WCG102890
DEFENDER 90 TD5	H: XA174548	WCE104440	WCG102940
DEFENDER 90 TD5	D: XA174548	WCE105170	WCG102940
DEFENDER 110 200 TDI		ESR54	ESR359
DEFENDER 110 300 TDI		ESR2383	ESR2384
DEFENDER 110 TD5		WCE105180	WCG103020
DISCOVERY 200 TDI	H: GA460229	NTC6791	NTC7119
	H: LA081991	ESR238 (COMPLETO)	
DISCOVERY 300 TDI	D: MA081992	ESR2391 (COMPLETO)	
DISCOVERY II TD5		WDE100590	WDE100660
RANGE ROVER V8 (1 SALIDA TRASERA)	PRIMITIVO	594973	594779
RANGE ROVER V8	H: 1985	NRC1973	
RANGE ROVER V8 (2 SALIDAS TRASERA)	H: 1983		NRC4563
RANGE ROVER V8 (2 SALIDAS TRASERA)	D: 2AA125322 1AA125310 4AA121865 3AA121296		NRC7185
RANGE ROVER V8 (2 SALIDAS TRASERA)	D: CA; H: FA	NTC1322	NRC1322
RANGE ROVER V8	D: GA	ESR560 (COMPLETO)	
RANGE ROVER 2.4 VM DIESEL		NTC1484	NTC2960
RANGE ROVER 2.5 VM DIESEL		NTC7362 (COMPLETO)	
RANGE ROVER 200 TDI	H: LA647655	ESR1855 (COMPLETO)	
RANGE ROVER 300 TDI	D: MA647645	ESR2380 (COMPLETO)	



H: Hasta el año correspondiente. D: Desde el año correspondient

GRUPO 11 : ESCAPES



		INTERMEDIO	TRASERO
NEW RANGE GASOLINA (SIN CATALIZADOR)		ESR3195	ESR3538
NEW RANGE GASOLINA (CON CATALIZADOR)	H: VA376579	ESR3195	
NEW RANGE GASOLINA (CON CATALIZADOR)	H: WA410481	WCE103880	CONSULTAR SALIDAS
NEW RANGE GASOLINA (CON CATALIZADOR)	D: XA410482	WCE104310	
NEW RANGE DIESEL	H: VA346794	ESR3194	ESR3196
NEW RANGE DIESEL (2 SALIDAS LD)	H: WA410481	ESR3194	WDV10070
NEW RANGE DIESEL (2 SALIDAS LI)	H: WA410481	ESR3194	WDV100260
NEW RANGE DIESEL (2 SALIDAS LD)	D: XA410482	ESR3194	WD100270
NEW RANGE DIESEL (2 SALIDAS LI)		ESR3194	WDV100260
FREELANDER GASOLINA		CONSULTAR	
FREELANDER DIESEL		CONSULTAR	



GRUPO 12 : ESCOBILLAS

DELANTERAS

	REF
DEFENDER 90/110/130	PRC8559 / DKC100980
RANGE TODOS LOS MODELOS	RTC6787
RANGE TODOS LOS MODELOS	PRC9841
NEW RANGE	AMR2297
NEW RANGE	DKC100830
DISCOVERY 200 TDI	AMR1805
DISCOVERY 300 TDI	AMR1805
DISCOVERY II	DKC100890
FREELANDER L/I	AWR4680
FREELANDER L/D	AWR4113

TRASERAS

	REF
DEFENDER 90/110/130	PRC8559
DEFENDER 90/110/130	DKC100980
DEFENDER 130 TODOS LOS MODELOS	PRC8559
RANGE TODOS LOS MODELOS	RTC6787
RANGE TODOS LOS MODELOS	PRC9841
NEW RANGE	PRC7576
DISCOVERY 200 TDI	AMR1806
DISCOVERY 300 TDI	AMR1806
DISCOVERY II	DKC100890
FREELANDER	AWR4116



H: Hasta el año correspondiente. D: Desde el año correspondiente

GRUPO 13 : FILTROS



FILTROS DE ACEITE

REF

DEFENDER 90 2.5L DIESEL Y TD		ERR3340
DEFENDER 90 V8		ERR3340
DEFENDER 90 200 TDI		ERR3340
DEFENDER 90 300 TDI		ERR3340
DEFENDER 90 TD5	(CARTUCHO)	LPX100590
DEFENDER 90 TD5	(ROTOR)	ERR6299
DEFENDER 110 4 CIL.		ERR3340
DEFENDER 110 2.5L DIESEL Y TD		ERR3340
DEFENDER 110 V8		ERR3340
DEFENDER 110 200 TDI		ERR3340
DEFENDER 110 300 TDI		ERR3340
DEFENDER 110 TD5	(CARTUCHO)	LPX100590
DEFENDER 110 TD5	(ROTOR)	ERR6299
RANGE V8 (PRIMITIVO)	H: 1976	RTC3186
RANGE V8	H: 1985	ERR3340
RANGE 3.5L CARBURACION	D: 1986	ERR3340
RANGE 3.5L EFI	D: 1986	ERR3340
RANGE 3.9L EFI	D: 1986	ERR3340
RANGE 4.2L EFI	D: 1986	ERR3340
RANGE 2.4L TD (VM)	D: 1989	AEU2218L
RANGE 2.5L TD (VM)	D: 1989	AEU2218L
RANGE 200 TDI	D: 1992-94	ERR3340
RANGE 300 TDI	D: 1995	ERR3340
NEW RANGE GASOLINA		ERR3340
NEW RANGE DIESEL	H: MOTOR 33978348	STC2180
NEW RANGE DIESEL	D: MOTOR 33988349	STC3350
DISCOVERY 200 TDI	D: 1990-992	ERR3340
DISCOVERY 300 TDI	D: 1995	ERR3340
DISCOVERY II TD5	(CARTUCHO)	LPX100590
DISCOVERY II TD5	(ROTOR)	ERR6299
FREELANDER DIESEL T.CIE		ERR5542
FREELANDER DIESEL TD4		LRF100150L
FREELANDER GASOLINA 1.8cc		CDU1268
FREELANDER GASOLINA V6		LPW100230



H: Hasta el año correspondiente. D: Desde el año correspondiente

GRUPO 13 : FILTROS



FILTROS DE AIRE

		REF
DEFENDER 90 4 CIL.	D: 1984	NRC9238
DEFENDER 90 2.5L DIESEL Y TD	D: 1984	NRC9238
DEFENDER 90 V8	D: 1985	RTC3479
DEFENDER 90 200 TDI	D: 1995	NTC6660
DEFENDER 90 300 TDI	D: 1995	ESR2623
DEFENDER 90 TD5	D: 1999	ESR4238
DEFENDER 110 4 CIL.	D: 1984	NRC9238
DEFENDER 110 2.5L DIESEL Y TD	D: 1984	NRC9238
DEFENDER 110 V8	D: 1985	RTC3479
DEFENDER 110 200 TDI	D: 1995	NTC6660
DEFENDER 110 300 TDI	D: 1995	ESR2623
DEFENDER 110 TD5	D: 1999	ESR4238
RANGE V8		605191
RANGE 3.5L CARBURACION	D: 1986	605191
RANGE 3.5L EFI	D: 1986	RTC4683
RANGE 3.9L EFI	D: 1989	RTC4683
RANGE 4.2L EFI	D: 1986	RTC4683
RANGE 2.4L TD (VM)	H: 1990	NTC1435
RANGE 2.5L TD (VM)	D: 1990	NTC1435
RANGE 200 TDI	D: 1992-94	ESR1049
RANGE 300 TDI	D: 1995	ESR1445
NEW RANGE GASOLINA	H: TA346793	ESR341
NEW RANGE GASOLINA	D: TA346794	ESR4238
NEW RANGE DIESEL	H: TA346793	ESR341
NEW RANGE DIESEL	D: TA346794	ESR4238
DISCOVERY 200 TDI	H: JA018272	NTC1435
DISCOVERY 200 TDI	D: JA018273 (CHAPA DE METAL)	ESR1049
DISCOVERY 300 TDI	D: 1995	ESR1445
DISCOVERY II TD5		ESR4238
FREELANDER DIESEL T.CIE		ESR4103
FREELANDER DIESEL TD4		ESR4103
FREELANDER GASOLINA 1.8cc		ESR4103
FREELANDER GASOLINA V6		ESR4238

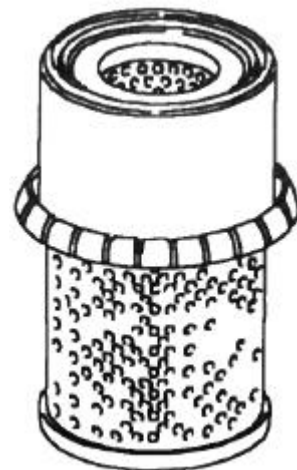

H: Hasta el año correspondiente. D: Desde el año correspondiente

GRUPO 13 : FILTROS



FILTROS DE CARBURANTE (GAS OIL/GASOLINA)

		REF
DEFENDER 90 4 CIL.	D: 1984	RTC6079
DEFENDER 90 2.5L DIESEL Y TD	D: 1984	RTC6079
DEFENDER 90 V8	D: 1985	JS660L
DEFENDER 200 TDI	D: 1990	AEU2147L
DEFENDER 300 TDI	D: 1990	AEU2147L
DEFENDER TD5		ESR4686
DEFENDER 110 4 CIL.	D: 1983	RTC6079
DEFENDER 110 2.5L DIESEL Y TD	D: 1983	RTC6079
DEFENDER 110 V8	D: 1983	JS660L
DEFENDER 200 TDI	D: 1990	AEU2147L
DEFENDER 300 TDI	D: 1990	AEU2147L
DEFENDER TD5		ESR4686
RANGE V8 <i>PRIMITIVO</i>	H :1976	JS660L
RANGE V8	D: 1976	JS660L
RANGE 3.5L <i>CARBURACION</i>	D: 1986	JS660L
RANGE 3.5L EFI	D: 1986	STC1677
RANGE 3.5L EFI	D: 1990	ESR4065
RANGE 3.9L EFI	H: 1989	STC1677
RANGE 3.9L EFI	D: 1990	ESR4065
RANGE 2.4L TD (VM)	H: 1990	AEU2147L
RANGE 2.5L TD (VM)	D: 1990	AEU2147L
NEW RANGE <i>GASOLINA</i>		ESR4065
NEW RANGE <i>DIESEL</i>		STC2827
DISCOVERY 200 TDI	D: 1990-92	AEU2147L
DISCOVERY 300 TDI	D: 1995	AEU2147L
DISCOVERY II TD5		ESR4686
FREELANDER <i>GASOLINA</i>		CONSULTAR
FREELANDER <i>DIESEL T.CIE</i>		WJN100046
FREELANDER TD4		WJ1100000L

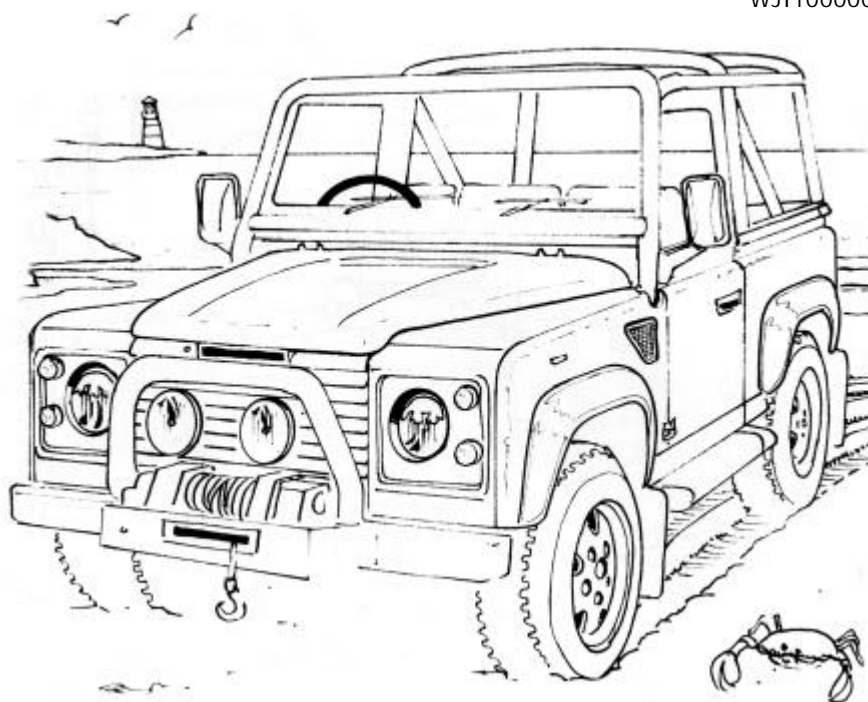

H: Hasta el año correspondiente. D: Desde el año correspondiente

GRUPO 14 : FRENOS



FRENOS DELANTEROS (PASTILLAS)

DEFENDER 110	D: 1983-86
DEFENDER 110/130	200/300
DEFENDER 90 (1)	H: 1985
DEFENDER 90 (2)	200
DEFENDER 90	200/300
DEFENDER 90/110	TD5
RANGE ROVER	H: 1985
RANGE ROVER	H: FA
RANGE ROVER	D: GA

NEW RANGE

DISCOVERY 200 (DISCO MACIZO)	H: KA034313
DISCOVERY 200 (DISCO VENTILADO)	
DISCOVERY 300	D: MA081992
DISCOVERY II TD5	

FREELANDER	H: YA999999
FREELANDER	D: 1A576764

FRENOS TRASEROS

DEFENDER 110	D: 1983-86
DEFENDER 110 200 TDI	
DEFENDER 130 300 TDI	
DEFENDER 110/130 300 TDI/TD5	
DEFENDER 90 200	
DEFENDER 90 300/TD5	

RANGE ROVER	H: 1986
RANGE ROVER	D: 1986-90
RANGE ROVER	D: 1990

NEW RANGE

DISCOVERY	CON AVISADOR
DISCOVERY	SIN AVISADOR
DISCOVERY II TD5	

FREELANDER	H: YA999999
FREELANDER	D: 1A576764

REF

STC2950 (P)
STC2952 (P)
STC9145 (P)
STC9191 (P)
STC2952 (P)
STC2952 (P)

STC9145 (P)
STC9187 (P)
STC9190 (P)

SFP100460 (P)

STC9187 (P)
STC9190 (P)
STC9191 (P)
SFP100480 (P)

SFP100360 (P)
SFP000010 (P)

REF

RTC3418 (Z)
RTC3418 (Z)
STC2798 (Z)
STC1601 (P)
STC2796 (Z)
STC9188 (P)

STC9188 (P)
STC9189 (P)
STC9189 (P)

SFP100470 (P)

STC9189 (P)
STC9188 (P)
SFP100490 (P)

SFS100140 (Z)
SFS000030 (Z)

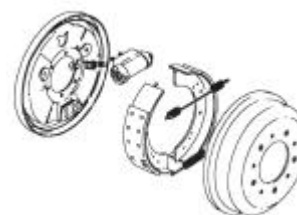

NOTA: (P) PASTILLAS; (Z) ZAPATAS); (1) HASTA EJE N° 23L05987 Y DESDE 23L06060 HASTA 06078;
(2) DESDE EJE N° 23L05988 HASTA 06059 Y DESDE 23L06079 HASTA CHASIS HA701009.

H: Hasta el año correspondiente. D: Desde el año correspondiente

GRUPO 14 : FRENOS



FRENO DE MANO (ZAPATAS)

		REF
DEFENDER 130 TDI	D: 1987	STC2990
DEFENDER 90 TDI		STC2990
RANGE 4 VELOCIDADES	H: 1986	STC2880
RANGE 5 VELOCIDADES	H: 1986	STC2990
RANGE 5 VELOCIDADES (LT230)	H: HA	STC965
RANGE 5 VELOCIDADES (BORG W.)	H: HA	STC965
RANGE 5 VELOCIDADES (BORG W.)	D: MA647645 (POR CABLE)	STC1525
RANGE 5 VELOCIDADES (BORG W.)	D: JA H: LA647644 (POR VARILLA)	STC965
NEW RANGE	H: WA410481	STC1525
NEW RANGE	D: XA410482	ICW100030
DISCOVERY (MANDO POR VARILLA)	D: 1991	STC965
DISCOVERY (MANDO POR CABLE)		ICW100030
DISCOVERY II TD5		ICW100030



BOMBA DE FRENO PRINCIPAL

		REF
DEFENDER 90 <i>TODOS LOS MODELOS</i>	(DISCO DELANTERO/TAMBOR TRASERO)	NRC9529
DEFENDER 200 TDI	(DISCO DELANTERO/TAMBOR TRASERO)	STC441
DEFENDER 300 TDI/TD5		SJC100460
DEFENDER 300 TDI/TD5		
DEFENDER 110 <i>TODOS LOS MODELOS</i>		
DEFENDER 110	H: HA901219	NRC8690
DEFENDER 110	D: HA901220	STC441
DEFENDER 110 300 TDI/TD5		SJC100460
RANGE ROVER		
BRIDA VERTICAL		RTC3657
BRIDA HORIZONTAL	H: DA301158	RTC3658
GIRLING	D: DA301159 H: LA647644	NTC4991
GIRLING	D: MA647645	STC1763
NEW RANGE	(BOMBA ABS)	STC2783
DISCOVERY 200 <i>SIN ABS</i>	H: LA081991	NTC4991
DISCOVERY 300 <i>SIN ABS</i>	D: MA081892	STC1285
DISCOVERY 300 <i>CON ABS</i>	D: MA081892	STC1284
DISCOVERY II TD5	D: XA232917	SJC100432
FREELANDER <i>CON ABS</i>	H: YA504975	SJC100370
FREELANDER <i>CON ABS</i>	D: YA504976 H: YA999999	SJC100371
FREELANDER <i>SIN ABS</i>	H: YA504955	SJC100380
FREELANDER <i>SIN ABS</i>	D: YA504976 H: YA999999	SJC100381
FREELANDER <i>TODOS LOS MODELOS</i>	D: 1A576764	SJC000010



H: Hasta el año correspondiente. D: Desde el año correspondiente

GRUPO 14 : FRENOS



DISCOS DELANTEROS

DEFENDER 90/110 200 TDI (MACIZOS) H: KA930544
 DEFENDER 90/110 200 TDI (MACIZOS) D: LA930456
 DEFENDER 90/110 300 TDI (VENTILADOS) D: LA930456
 DEFENDER 90/110 TD5 (MACIZOS)
 DEFENDER 90/110 TD5 (VENTILADOS)

RANGE ROVER

D: CA/H: FA (INCLUIDOS) H: 1985
 D: GA D: 1986-90
 D: 1990

NEW RANGE

DISCOVERY 200 Y 300 TDI
 DISCOS MACIZOS
 DISCOS VENTILADOS

DISCOVERY II TD5

FREELANDER (MACIZOS) H: YA999999
 FREELANDER (VENTILADOS) D: 1A576764

TRASEROS, DISCOS/TAMBORES

DEFENDER 90
 TAMBOR TRASERO (200 TDI)
 DISCO TRASERO (300 TDI)

DEFENDER 110/130
 TAMBOR TRASERO (200 TDI)
 DISCO TRASERO (300 TDI)
 DISCO TRASERO (TD5)

RANGE ROVER H: 1985
 DESDE CA D: 1986

NEW RANGE

DISCOVERY 200/300 TDI

DISCOVERY II TD5

FREELANDER (TAMBOR) H: YA999999
 FREELANDER (TAMBOR) D: 1A576764

BOMBIN DE FRENO

DEFENDER 90 TRAS L/D H: HA701009
 DEFENDER 90 TRAS L/I H: HA701010
 DEFENDER 90 TRAS L/D D: HA701010
 DEFENDER 90 TRAS L/I D: HA701010

DEFENDER 110 TRAS L/D
 DEFENDER 110 TRAS L/I

FREELANDER TRAS x2 H: YA999999
 FREELANDER TRAS X2 D: 1A576764

REF

FRC7329
 FRC7329
 FTC902
 FRC7329
 FTC902

571762
 FRC7329
 FTC902

NTC8780

FRC7329
 FTC902

ANR4582

SDB100830
 SDB000080

REF

591039
 FTC1381

576973
 FTC3846
 SDB100980

571912
 FTC1381

NTC8781

FTC1381

NTC8781

SFS100140
 SFS000030

REF

RTC3168
 RTC3169
 STC468
 STC467

RTC3626
 RTC3627

SML100070
 SML000010

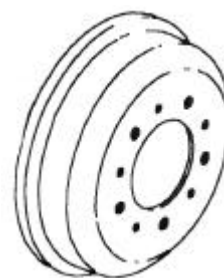
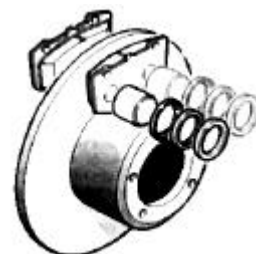

H: Hasta el año correspondiente. D: Desde el año correspondiente

GRUPO 15 : ILUMINACION



FAROS / OPTICAS DELANTEROS

		REF
DEFENDER 90/110	H: KA922614	PRC7994
DEFENDER 90/110	D: KA922615	STC1210
RANGE ROVER	H: JA624755	PRC7994
RANGE ROVER	D: KA624756	STC1210
NEW RANGE LADO IZQUIERDO		XBC105970
NEW RANGE LADO DERECHO		XBC105960
DISCOVERY 200 L/DERECHO	H: LA081991	STC767
DISCOVERY 200 L/IZQUIERDO		STC768
DISCOVERY 300 L/DERECHO	D: MA081992	STC1235
DISCOVERY 300 L/IZQUIERDO		STC1236
DISCOVERY II L/DERECHO		XBC105140
DISCOVERY II L/IZQUIERDO		XBC105150
FREELANDER (FARO+PILOTO) L/I	H: YA999999	AMR4000
FREELANDER (FARO+PILOTO) L/I	D: 1A576764	XBC000310
FREELANDER (FARO+PILOTO) L/D	H: YA999999	AMR4001
FREELANDER (FARO+PILOTO) L/D	D: 1A576764	XBC000300



PILOTOS DELANTEROS

		REF
DEFENDER 200 TDI POSICION TULIPA POSICION INTERMITENTE TULIPA INTERMITENTE	H: LA940004	RTC5012 589284 RTC5013 589285
DEFENDER 300 TDI/TD5 INTERMITENTE POSICION	D: MA940005	STC1228 STC1227
RANGE LADO DERECHO	H: HA	PRC5575
RANGE LADO IZQUIERDO	H: HA	PRC5576
RANGE LADO DERECHO	D: JA	PRC8949
RANGE LADO IZQUIERDO	D: JA	PRC8950
NEW RANGE LADO DERECHO	H: XA430701	AMR2690
NEW RANGE LADO DERECHO	D: YA430702	XBD100920
NEW RANGE LADO IZQUIERDO	H: XA430701	AMR2688
NEW RANGE LADO IZQUIERDO	D: YA430702	XBD100930
DISCOVERY 200 TDI LADO DERECHO		PRC9306
DISCOVERY 200 TDI LADO IZQUIERDO		PRC9307
DISCOVERY 300 TDI LADO DERECHO		XBD100760
DISCOVERY 300 TDI LADO IZQUIERDO		XBD 100770
DISCOVERY II LADO DERECHO		XBD100870
DISCOVERY II LADO IZQUIERDO		XBD100880

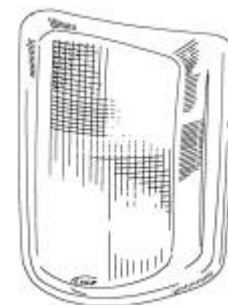

FREELANDER

VER FAROS / OPTICAS DELANTEROS

H: Hasta el año correspondiente. D: Desde el año correspondiente

GRUPO 15 : ILUMINACION



PILOTOS TRASEROS

	DEFENDER 200 TDI	DEFENDER 300 TDI
PARE/FRENO	RTC5523	STC1230
TULIPA	RTC210	NO PROCEDE
INTERMITENTE	RTC5524	STC1229
TULIPA	589285	NO PROCEDE
MATRICULA	XFC100550	XFC100550
TULIPA	NO PROCEDE	NO PROCEDE
ANTINIEBLA	PRC2516	PRC2516
TULIPA	RTC4183	RTC4183
MARCHA ATRAS	PRC3299	PRC3299
TULIPA	RTC4184	RTC4184

RANGE ROVER						
PERIODO	PILOTO LD	TULIPA TRAS LD	TULIPA EXT. LD	PILOTO LI	TULIPA TRAS LI	TULIPA EXT. LI
H:CA	RTC5901	RTC5551	RTC5294	RTC5902	RTC5552	RTC5295
D: DA (CON SECCION FRENO EN LA BASE)	PRC4741	RTC5551	RTC5294	PRC4742	RTC5552	RTC5295
D:DA (D:NOV87)	PRC7896	RTC5989	RTC5294	PRC7897	RTC5990	RTC5295
D:JA	PRC8952	RTC5989	RTC5294	PRC8953	RTC5990	RTC5295

HASTA CHASIS BA CONSULTAR POR DESPIECE (RANGE ROVER HASTA 1985)

PILOTO DE MATRICULA

H:CA PRC3824
D:DA PRC6066

NEW RANGE

INTERMITENTE LD
INTERMITENTE LD
INTERMITENTE LI
INTERMITENTE LI
COMPUERTA LD
COMPUERTA LD
COMPUERTA LI
COMPUERTA LI
3ª LUZ FRENO COMPUERTA

H: XA430701
D: YA430701
H: XA430701
D: YA430701
H: XA430701
D: YA430701
H: XA430701
D: YA430701

REF

AMR4100
XFB101720
AMR4099
XFB101730
AMR4724
XFE100220
AMR4725
XFE100230
PRC7644



DISCOVERY II

PARE LADO DERECHO
PARE LADO DERECHO
PARE LADO DERECHO
PARE LADO IZQUIERDO
PARE LADO IZQUIERDO
PARE LADO IZQUIERDO

PILOTO EN CARROCERIA

H: YA274082
D: YA274083
D: 1A294132
H: YA274082
D: YA274083
D: 1A294132

REF

XFB101680
XFB000040
XFB000160
XFB101690
XFB000050
XFB000170

H: Hasta el año correspondiente. D: Desde el año correspondiente

GRUPO 15 : ILUMINACION



PILOTOS TRASEROS

DISCOVERY 200 TDI

LADO DERECHO: PRC6475
LADO IZQUIERDO: PRC6476

DISCOVERY 300 TDI

(INTERMITENTES EN PILOTO PARAGOLPES TRASERO)

LD PARE/POSICION: AMR1295
LI PARE/POSICION: AMR1294

LD INTERMITENTE: AMR6510
LI INTERMITENTE: AMR6509

DISCOVERY II

(INTERMITENTES EN PILOTO PARAGOLPES TRASERO)

LD INTERMITENTE XFB101480
LI INTERMITENTE XFB101490

FREELANDER

(EN CARROCERIA)

LD MARCHA ATRAS/ANTINEBLA: AMR4003
LI MARCHA ATRAS/ANTINEBLA: AMR4002

(EN PARAGOLPES)

LD INTERMITENTE/PARE: AMR3990
LI INTERMITENTE/PARE: AMR3989

PARE SOBRE RUEDA PORTON TRAS: AMR4104



PILOTOS DE ALETA

REF

DEFENDER	H: 331793	589143
	D: 331794	PRC7044
	D: MA936676	PRC9916
RANGE ROVER	H: 100782	589143
	H: CA	PRC4562
	D: DA	PRC7441
	D: JA	AFU3341L
NEW RANGE	H: XA430701	PRC9916
NEW RANGE	D: YA430702	XGB100280
DISCOVERY		PRC9916
DISCOVERY II		AMR4103
FREELANDER		AMR4103



H: Hasta el año correspondiente. D: Desde el año correspondiente

GRUPO 16 : JUNTAS HOMOCINETICAS



NOTA: Algunos modelos de Junta Homocinética son polivalentes para vehículos con o sin ABS.

JUNTAS HOMOCINETICAS

REF

DEFENDER 90/110	H: LA930455	23 ESTRIAS	AEU2522
DEFENDER 90/110		33 ESTRIAS	RTC6862
DEFENDER 90/110	D: LA930456	24 ESTRIAS	STC3051
DISCOVERY	H: JA032850		RTC5843
DISCOVERY	D: JA032851	SIN ABS (10 ESTRIAS)	RTC6811
DISCOVERY		SIN ABS (24 ESTRIAS)	STC3051
DISCOVERY		CON ABS (24 ESTRIAS)	STC3051
RANGE ROVER	H: EA305589		606665
RANGE ROVER	H: JA624516	SIN ABS	RTC5843
RANGE ROVER	D: KA624756	SIN ABS (10 ESTRIAS)	RTC6811
RANGE ROVER		SIN ABS (24 ESTRIAS)	STC3051
RANGE ROVER	D: GA	CON ABS (10 ESTRIAS)	RTC6811
RANGE ROVER		CON ABS (24 ESTRIAS)	STC3051
NEW RANGE			STC3204
FREELANDER			TDJ100470



GRUPO 17 : MOTOR DE ARRANQUE

MOTOR DE ARRANQUE

REF

DEFENDER 200 TDI	ERR5009
DEFENDER 300 TDI	ERR5009
DEFENDER TD5	NAD101240
RANGE V8	RTC6061
RANGE 2.4 TD VM	PRC5669
RANGE 2.5 TD VM	PRC5669
RANGE 200 TDI	ERR5009
RANGE 300 TDI	ERR5009
NEW RANGE DIESEL	ERR5445
NEW RANGE GASOLINA	NAD101490
DISCOVERY 200 TDI	ERR5009
DISCOVERY 300 TDI	ERR5009
DISCOVERY II TD5	NAD101240
FREELANDER GASOLINA 1.8cc	NAD101090
FREELANDER GASOLINA V6	NAD100952L
FREELANDER DIESEL T.CIE	NAD100580
FREELANDER DIESEL TD4	NAD101500

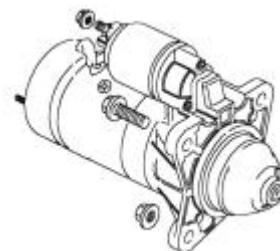

H: Hasta el año correspondiente. D: Desde el año correspondiente

GRUPO 18 : MOTORES



RANGE ROVER / NEW RANGE MOTOR V8

		REF
ARBOL DE LEVAS	3.5	ETC6099
	3.9	ERR5924
	4.2 H: 659897	ERR4946
	4.2 D: 659898	ERR5925
	4.0	ERR3720
	4.6	ERR5250
CADENA DISTRIBUCION	TODOS	ERC7929
COJINETE DE BANCADA STANDARD (JUEGO)	3.5 / 3.9 / 4.2	RTC1718
	4.0 / 4.6	STC1425
COJINETE DE BIELA STANDARD (JUEGO)	3.5 / 3.9 / 4.2	RTC2117
	4.0 / 4.6	ERR1773
PIÑÓN ARBOL DE LEVAS	3.5 / 3.9 / 4.2	610289
	4.0 / 4.6 H: WA410481	ERR5086
	4.0 / 4.6 D: XA410482	ERR7375
PIÑÓN DEL CIGÜEÑAL	3.5 / 3.9 / 4.2	90602372
	3.9 / 4.2 D: 35D08967B / 36D25524B / 37D01932B / 38D27331B / 40D09582B	ERR2958
	4.0 / 4.6	ERR2958
PISTON (CON SEGMENTOS-STANDARD)	3.5 CARB. & INY. 8:13	RTC2186S
	3.5 CARB. & INY. 9:35	RTC2295S
	3.9 INY. 8:13	STC908S
	3.9 INY. 9:35	STC909S
	4.2 INY. 8:94	STC1191S
	4.0 INY. 8:12	ERR5555
	4.0 INY. 9:35	ERR5553
	4.6 INY. 8:12	ERR5556
4.6 INY. 9:35	ERR5554	
RETEN DEL CIGÜEÑAL	TODOS	ERR6490
RETEN TRASERO DEL CIGÜEÑAL	3.5 PRIMITIVO (2 MEDIAS LUNAS)	RTC811
	TODOS	ERR2640
SEGMENTO (STANDARD)	3.5	RTC2408
	3.9 / 4.2	RTC6066
	4.0 / 4.6	STC1427

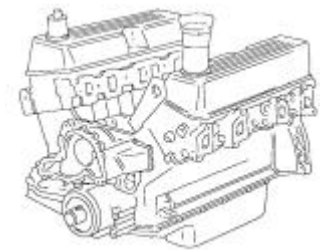

H: Hasta el año correspondiente. D: Desde el año correspondiente

GRUPO 18 : MOTORES



RANGE ROVER / NEW RANGE MOTOR V8		REF
JUNTA DE CULATA	3.5	603796
	3.9	ETC7819
	4.2 / 4.0 / 4.6	ERR7217
JGO. JUNTAS MOTOR INFERIOR (JGO. DESCARB.)	3.5 CARB. PRIMITIVO SUFIJO: A	RTC811
	3.5 / 3.9 / 4.2	STC1639
	4.0 / 4.6	DESPIECE
JGO. JUNTAS MOTOR SUPERIOR (JGO. DESCARB.)	3.5 CARBURACION	RTC3337
	3.5 INYECCION	STC1642
	3.9 INYECCION	STC1641
	4.0 / 4.6	DESPIECE
TAQUE HIDRAULICO	TODOS	ERC4949
VALVULA DE ADMISION	3.5 CARB. PRIMITIVO 355, 359 SUF: A, B, C, D, E.	602166
	3.5 / 3.9	STC1121
	3.9 / 4.2 D: 35D6577A / 36D14150A / 37D00752A / 38D23046A / 40D	ERR1780
	4.0 / 4.6	ERR1780
VALVULA DE ESCAPE	3.5 CARB. PRIMITIVO 355, 359 SUF: A, B, C, D, E.	602165
	3.5 CARB. / EFI	STC1122
	3.9 / 4.2 D: 35D6577A / 36D14150A / 37D00752A / 38D23046A / 40D	ERR1781
	4.0 / 4.6	ERR7388
VARILLA TAQUE	TODOS	603378

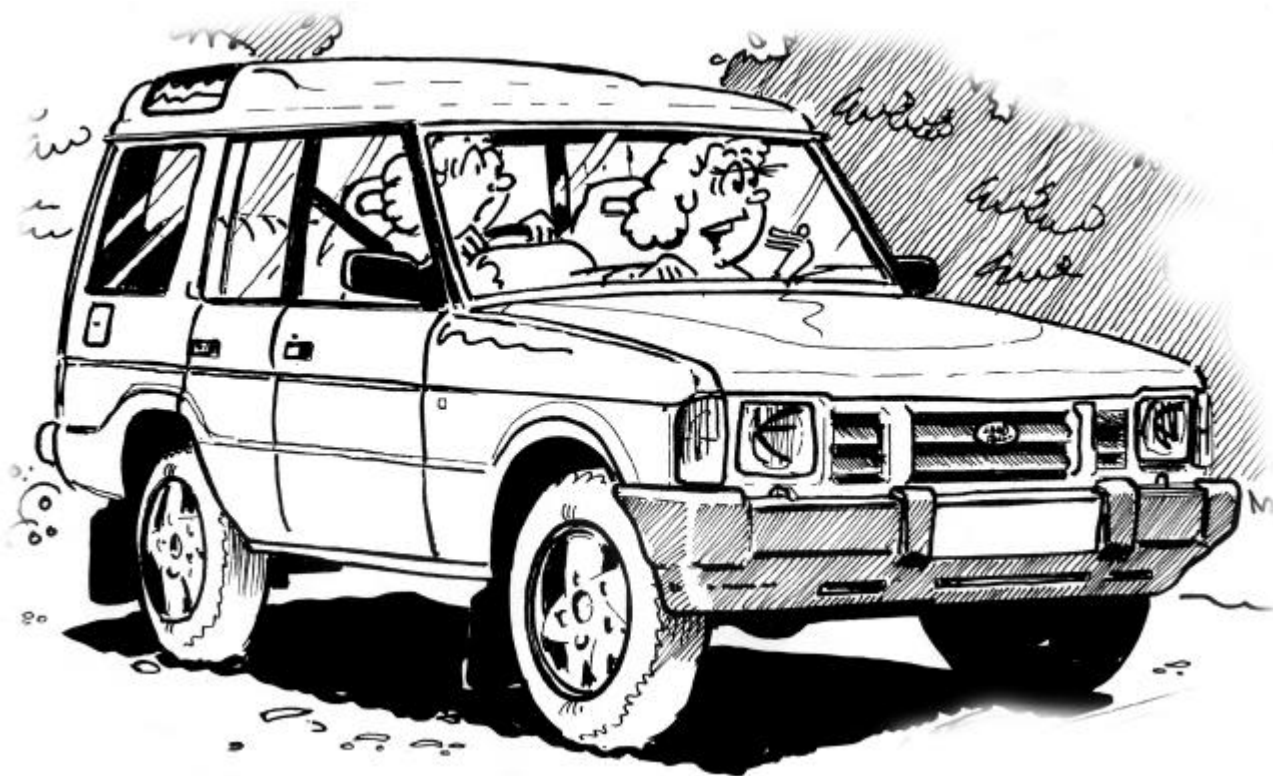
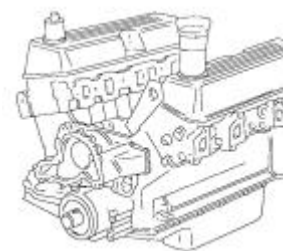

H: Hasta el año correspondiente. D: Desde el año correspondiente

GRUPO 18 : MOTORES



RANGE ROVER 2.4 & 2.5 MOTOR VM		REFERENCIA	
		2.4	2.5
ARBOL DE LEVAS		BAU5313	BAU5313
BOMBA DE ACEITE (INCLUYE PIÑON)		AEU2144L	AEU2144L
BOMBA DE VACIO		RTC4995	RTC6644 (+ PIÑON)
CAMISA CILINDRO		AEU2001L	AEU2001L
COJINETES ARBOL DE LEVAS (X3)	STANDARD	AEU2134L	AEU2134L
COJINETES BANCADA (JUEGO)	STANDARD	STC651	STC651
COJINETES BIELA (1 BIELA)	STANDARD	AEU2039L	AEU2039L
CULATIN (X4)		STC653	STC1347
INTERRUPTOR PRESION DE ACEITE		PRC6387	PRC6387
JUEGO JUNTAS INFERIOR (BLOQUE)		STC1623	STC1623
JUEGO JUNTAS SUPERIOR		STC850	STC850
JUNTA COLECTOR DE ESCAPE		RTC4893	RTC4893
JUNTA CULATA 1.42mm (SIN MUESCAS)		STC1570	STC1570
JUNTA CULATA 1.52mm (2 MUESCAS)		STC1571	STC1571
JUNTA CULATA 1.62mm (1 MUESCA)		STC1844	STC1844
JUNTA TAPA BALANCINES (JUEGO)		STC814	STC814
JUNTAS COLECTOR DE ADMISION		STC804	STC804
PIÑON ARBOL DE LEVAS		AEU2139L	AEU2139L
PIÑON BOMBA DE VACIO		RTC5829	VER BOMBA
PIÑON BOMBA INYECTORA		RTC5829	RTC6661
PIÑON CIGÜEÑAL		AEU2010L	AEU2010L
PIÑON LOCO DE DISTRIBUCION	SUF: A	AEU2141L	
	SUF: B	RTC6681	
PISTON (CON SEGMENTOS STANDARD)		AEU2909L	RTC6646
RETEN DELANTERO DEL CIGÜEÑAL		RTC6771	RTC6771
RETEN TRASERO CIGÜEÑAL		RTC6710	RTC6710
SEGMENTOS (JUEGO 1 PISTON)		LFP10081L	LFP10081L
SUPLEMENTO CAMISA	0.15mm	AEU2272L	AEU2272L
	0.20mm	AEU2273L	AEU2273L
	0.23mm	AEU2090L	AEU2090L
TAPA BALANCINES (INTERMEDIO)		RTC6450	RTC6450
TAPA BALANCINES DEL (LLENADO ACEITE)		RTC6449	RTC6449
TAPA BALANCINES TRASERA		RTC6451	RTC6451
TRANSMISOR DE TEMPERATURA		RTC4996	PRC8170
TUBO LLENADO ACEITE A TURBO		RTC4960	RTC4960
TUBO VACIADO ACEITE DE TURBO		RTC4941	RTC4941
VARILLA DE EMPUJE DEL TAQUE		AEU2070L	AEU2070L

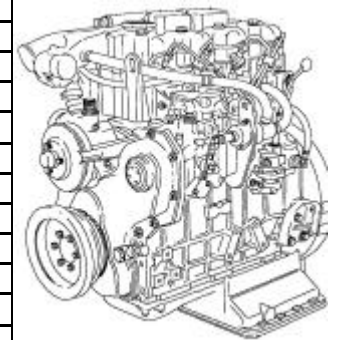

H: Hasta el año correspondiente. D: Desde el año correspondiente

GRUPO 18 : MOTORES



DEFENDER/RANGE ROVER/DISCOVERY	REF
--------------------------------	-----

MOTOR 200 TDI / 300 TDI		200	300
ARBOL DE LEVAS		ETC7128	ERR3547
BALANCIN LADO DERECHO (X4)		ERR1202	ERR3343
BALANCIN LADO IZQUIERDO (X4)		ERR1201	ERR3342
BOMBA DE ACEITE		ERR1178	STC3407
CIGÜEÑAL		ERR1181	ERR2112
COJINETE ARBOL DE LEVAS (DELANTERO)		ETC8442	ETC8442
COJINETE ARBOL DE LEVAS (TRASERO)		90519055	90519055
COJINETES DE BANCADA (JUEGO)	STANDARD	STC3395	STC3395
COJINETES DE BANCADA (JUEGO)	010"	RTC478310	RTC478310
COJINETES DE BIELA (JUEGO)	STANDARD	RTC2993	RTC2993
COJINETES DE BIELA (JUEGO)	010"	RTC299310	RTC299310
CONTRAPESO (DAMPER DEL CIGÜEÑAL)		ERR751	ERR2220
FUNDA VARILLA NIVEL DE ACEITE	DISCO/RANGE	ERR1248	ERR4697
FUNDA VARILLA NIVEL DE ACEITE	DEFENDER	ERC8980	ERR4697

INTERRUPTOR DE TEMPERATURA (EN ALOJAMIENTO TERMOSTATO)			
DOBLE CLEMA		PRC3359	
DISCOVERY COLOR VERDE			PRC3359
DISCOVERY AMARILLO			PRC3505
DEFENDER VERDE			AMR1425
DEFENDER NEGRO			AMR3321
RANGE ROVER			AMR1425
INTERRUPTOR DE TEMPERATURA	(EN CULATA)		ERR2081
INTERRUPTOR PRESION DE ACEITE		PRC6387	PRC6387



INYECTOR (X4)		ETC8412	ERR3339
JUEGO JUNTAS MOTOR SUPERIOR		STC1172	STC2802
JUEGO JUNTAS MOTOR INFERIOR		STC1557	STC2801
JUNTA CARTER ACEITE	SELLANTE	STC611	STC611
JUNTA COLECTOR ADMISION		ERR1208	ERR3785
JUNTA CULATA 1.3mm (1 MUESCA)		ERR5261	ERR5261
JUNTA CULATA 1.4mm (2 MUESCAS)		ERR5262	ERR5262
JUNTA CULATA 1.5mm (3 MUESCAS)		ERR5263	ERR5263
JUNTA TAPA BALANCINES		ERR2393	ERR2409
JUNTA TAPA DISTRIBUCION DELANTERA	DISCO/RANGE	ERR1195	ERR7293
JUNTA TAPA DISTRIBUCION DELANTERA	DEFENDER	ERR1553	ERR7293
JUNTA TAPA DISTRIBUCION TRASERA		538039	ERR4860
PISTON (CON SEGMENTOS)	STANDARD (GX)	ERR1390	ERR2410
PISTON (CON SEGMENTOS)	STANDARD (GY)	ERR1391	
PISTON (CON SEGMENTOS)	010"		STC298210
PISTON (CON SEGMENTOS)	020"	STC105220	STC298220
PISTON (CON SEGMENTOS)	040"	STC105240	STC298240
POLEA			ERR2798

H: Hasta el año correspondiente. D: Desde el año correspondiente

GRUPO 18 : MOTORES



DEFENDER/RANGE ROVER/DISCOVERY		REF	
MOTOR 200 TDI / 300 TDI		200	300
RETEN DISTRIBUCION ARBOL LEVAS		ETC5064	ERR3356
RETEN DISTRIBUCION CIGÜEÑAL EXTERIOR		ETC4154	ERR4576
RETEN DISTRIBUCION CIGÜEÑAL INTERIOR		ERR6490	ERR4575
RETEN TRASERO CIGÜEÑAL (<i>RETEN</i>)		ERR2532	LUF100430
RETEN TRASERO CIGÜEÑAL (<i>JUNTA</i>)			ERR6811
RETEN/CAPUCHON VASTAGO VALVULA (<i>X8</i>)		LJC100270	LJC100270
SEGMENTOS (<i>JUEGO</i>)	<i>STANDARD</i>	RTC6457	STC958
SEGMENTOS (<i>JUEGO</i>)	<i>020"</i>	RTC645720	
SOPORTE			ERR7386
TAPON LLENADO ACEITE		ERR5041	ERR5041
TAPON CARTER DE ACEITE		603659	UAM2957L
TENSOR			ERR7387
SOPORTE TENSOR			ERR7386
TENSOR AIRE ACONDICIONADO		614718	
VALVULA ADMISION		ERR1157	ERR3777
VALVULA DE ESCAPE (<i>X4</i>)		ERR1156	ERR1156
VARILLA NIVEL DE ACEITE	<i>DISCO/RANGE</i>	ERR1103	ERR3809
VARILLA NIVEL DE ACEITE	<i>DEFENDER</i>	ETC7867	ERR3809
VARILLA TAQUE (<i>X8</i>)		546799	546799

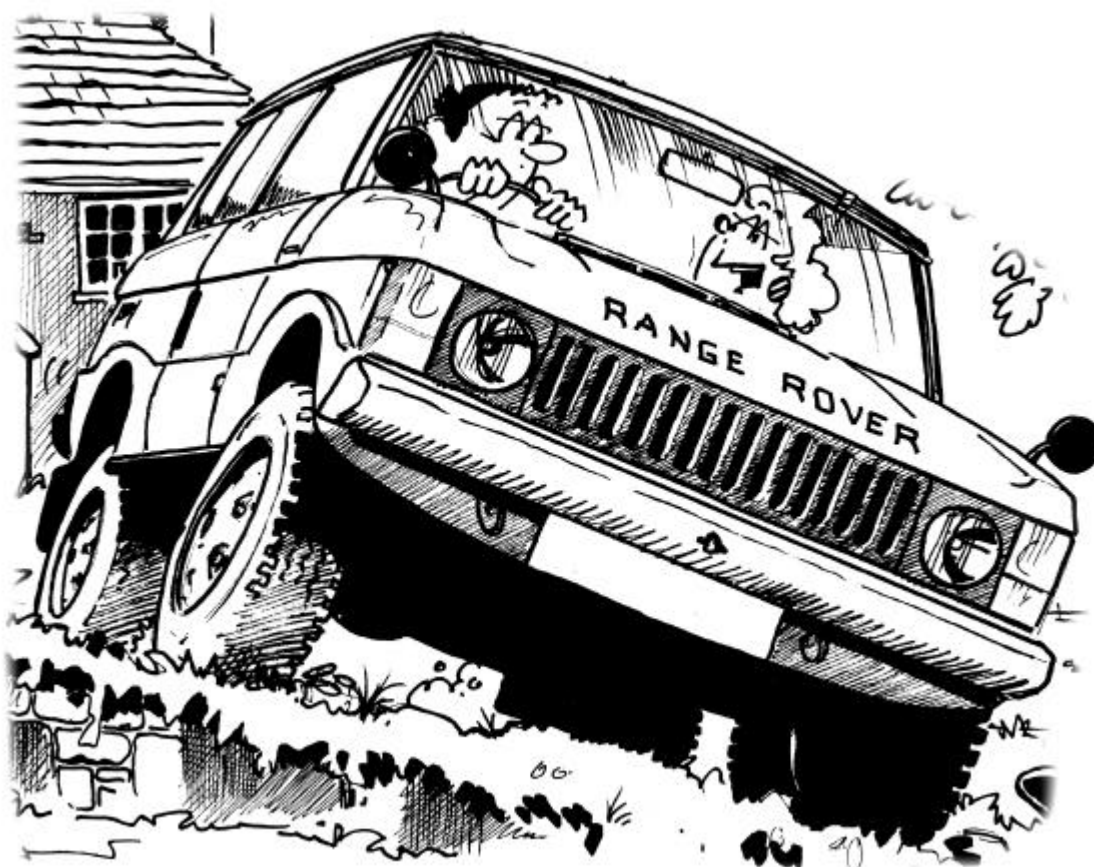
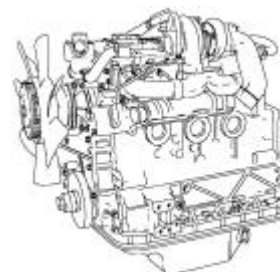

H: Hasta el año correspondiente. D: Desde el año correspondiente

GRUPO 19 : REFRIGERACION

TERMOSTATO

DEFENDER 200 TDI
DEFENDER 300 TDI
DEFENDER TD5

RANGE 3.5 *CARBURACION (88°)*
RANGE 3.5 Y 3.9 EFI
RANGE 2.4 TD VM
RANGE 2.5 TD VM
RANGE 200 TDI
RANGE 300 TDI

NEW RANGE GASOLINA
NEW RANGE DIESEL

DISCOVERY 200 TDI
DISCOVERY 300 TDI
DISCOVERY II TD5

FREELANDER GASOLINA 1.8cc
FREELANDER GASOLINA V6
FREELANDER DIESEL T.CIE
FREELANDER DIESEL TD4

CENTRÍFUGO/VISCOZO

DEFENDER 200 TDI
DEFENDER 300 TDI
DEFENDER TD5

RANGE 3.5 *CARBURACION VENTILADOR 7 ASPAS*
RANGE 3.5 Y 3.9 EFI/ *VENTILADOR 11 ASPAS*
RANGE 3.5 Y 3.9 EFI/ *VENTILADOR 7 ASPAS*
RANGE 2.4 TD VM
RANGE 2.5 TD VM
RANGE 200 TDI
RANGE 300 TDI

NEW RANGE GASOLINA
NEW RANGE TD

DISCOVERY 200 TDI
DISCOVERY 300 TDI

DISCOVERY II TD5

FREELANDER (X1 UNIDAD) GASOLINA
FREELANDER (X1 UNIDAD) GASOLINA
FREELANDER (X2 UNIDADES) DIESEL T.CIE
FREELANDER TD4

H: YA999999
D: 1A576764
H: YA999999
D: 1A576764

REF

ERR2803
ERR3291
PEM100990

ETC4765
ETC4765
RTC4942
RTC6673
ERR2803
ERR3291

ESR2857
STC3338

ERR2803
ERR3291
PEM100990

PEL10016
PEM000030
PEM101020
PEL100570L

VISCOZO

ETC7238
ERR2266
PGG101050

ERC2849
ETC1260
ERC2849
ETC1260
ETC1260
ETC7238
ERR2266

ERR4996
ERR4397

ETC7238
ERR2266

PGG101050

VENTILADOR

ERR3380
ERR2789
INCL. VISCOZO

614739
ETC1275
614739
ETC1275
ETC1275
ERR3380
ERR2789

ERR4960
ERR2789

ERR3380
ERR2789

INCL. VISCOZO

PGJ100310
PGF000010
PGJ100130
PGF1000010

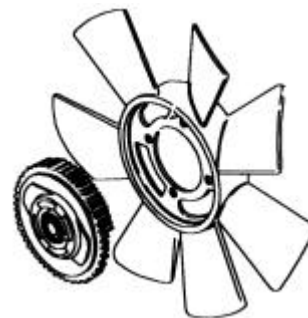

GRUPO 20 : SILENTBLOCKS

DEFENDER

BARRA PANHARD	
TIRANTE BRAZO DEL/MEDIA LUNA	H: LA930455
TIRANTE BRAZO DEL/MEDIA LUNA	D: LA930456
TIRANTE BRAZO DEL/SUPERIOR	
TIRANTE BRAZO TRAS/LATERAL	
TIRANTE BRAZO TRAS/TRIANGULAR (JUEGO)	
PUENTE TRIANGULAR CENTRAL/TRAS	
ROTULA CENTRAL TRASERA	

RANGE ROVER HASTA 1985

BARRA PANHARD	
TIRANTE BRAZO DEL/MEDIA LUNA	
TIRANTE BRAZO DEL/SUPERIOR	
TIRANTE BRAZO TRAS/LATERAL	
TIRANTE BRAZO TRAS/TRIANGULAR (JUEGO)	
PUENTE TRIANGULAR CENTRAL/TRAS	
ROTULA CENTRAL TRASERA	

RANGE ROVER DESDE 1986

BARRA PANHARD	
TIRANTE BRAZO DEL/MEDIA LUNA	H: GA464553
TIRANTE BRAZO DEL/MEDIA LUNA	D: HA464554
TIRANTE BRAZO DEL/SUPERIOR	
TIRANTE BRAZO TRAS/LATERAL	
TIRANTE BRAZO TRAS/TRIANGULAR (JUEGO)	
PUENTE TRIANGULAR CENTRAL/TRAS	
ROTULA CENTRAL TRASERA	

NEW RANGE

BARRA PANHARD	
TIRANTE BRAZO DEL/MEDIA LUNA	
TIRANTE BRAZO DEL/LATERAL	
TIRANTE BRAZO TRASERO	

DISCOVERY 200/300 TDI

BARRA PANHARD	
TIRANTE BRAZO DEL/MEDIA LUNA	
TIRANTE BRAZO DEL/LATERAL	
TIRANTE BRAZO TRAS/LATERAL	
TIRANTE BRAZO TRAS/TRIANGULAR (JUEGO)	
PUENTE TRIANGULAR CENTRAL/TRAS	
ROTULA CENTRAL TRASERA	

FREELANDER

BRAZO DEL/LATERAL	
BRAZO DEL/LATERAL (ESPARRAGO)	
BRAZO TRAS/LATERAL	
BARRA TRASERA EXTERIOR	
BARRA TRASERA INTERIOR	
BARRA AJUSTADORA TRAS/EXT	
BARRA ESTABILIZADORA DEL	H: YA999999
BARRA ESTABILIZADORA DEL	D: 1A576764

QTY	REF
X2	ANR3410
X4	NTC7307
X4	NTC6781
X4	NRC4514
X2	NTC1772
X1	STC618
X2	NTC1773
X2	ANR1799

QTY	REF
X2	575580
X4	NTC7307
X4	572068
X2	NTC1772
X2	572180
X2	NTC1773
X1	ANR1799

QTY	REF
X2	ANR3410
X4	NTC6860
X4	NTC6781
X4	NRC4514
X2	NTC1772
X1	STC618
X2	NTC1773
X1	ANR1799

QTY	REF
X2	ANR3671
X4	ANR3332
X4	NRC4514
X1	ANR3285

QTY	REF
X2	ANR3410
X4	NTC6860
X4	NRC4514
X2	NTC1772
X1	STC618
X2	NTC1773
X1	ANR1799

QTY	REF
X2	RBX101160
X1	ANR6109
X1	RGX101000
X1	RGX101440
X1	RGX101030
X2	RGX101020
X1	RBX101240
X1	RBX000010



TIRANTE TRASERO



BARRA RADIAL

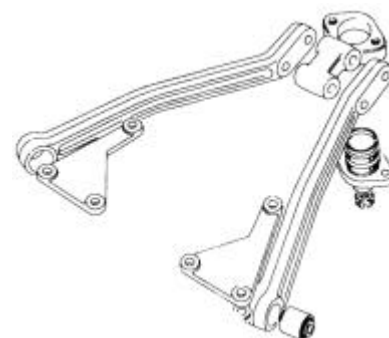

PUENTE TRIANGULAR



BARRA PANHARD

H: Hasta el año correspondiente. D: Desde el año correspondiente

GRUPO 21 : TRANSMISION



CRUCETAS

DEFENDER
DISCOVERY
RANGE ROVER
NEW RANGE ROVER
FREELANDER
DISCOVERY II TD5

REF

RTC3458
RTC4587
RTC4587
RTC4587
TVF100000
TVC100010

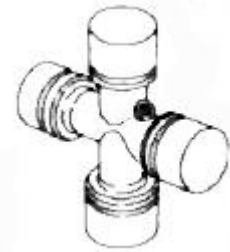

ARBOL DE TRANSMISION

DEFENDER 110/130 200 TDI
DEFENDER 110/130 300 TDI
DEFENDER 90
DEFENDER 90 200 TDI
DEFENDER 90 300 TDI
DISCOVERY 200/300 TDI
DISCOVERY II TD5
RANGE (MANUAL)
RANGE (AUTOMATICO)
RANGE (V8/TD/VM) CON
TRANSFER ROVER
RANGE (V8/TD/VM/TDI) CON
TRANSFER BORG WARNER
RANGE 3.9 INYECTION
NEW RANGE ROVER
NEW RANGE ROVER DIESEL AUTOM.
FREELANDER

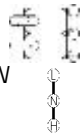

DELANTERO

D: MA939976
H: 252578
D: 252578
D: MA939976

H: 1.986
H: 1.986
D: 1.986
D: 1.986

D: 1.986
TODOS
D: 004298

REF

FRC8390
FRC8386
FRC5566
FRC8390
FRC8386
FRC8386
TVB000100
STC666
FRC8641
FRC8386

FTC122
FRC9542
FTC4140
TUB000130
TVB000090

ARBOL DE TRANSMISION

DEFENDER 130 (DIESEL)
DEFENDER 110
DEFENDER 110 200 TDI
DEFENDER 110 300 TDI
DEFENDER 90
DEFENDER90 200/300 TDI

DISCOVERY 200 TDI
DISCOVERY 300 TDI

DISCOVERY II TD5

RANGE ROVER
RANGE ROVER

RANGE ROVER

NEW RANGE
NEW RANGE DIESEL AUTOMATICO

FREELANDER

TRASERO

H: KA925786
D: KA925787

H: 252578

H: LA081991
D: MA081992

REF

FTC1250
FRC8391
FTC3245
FTC3905
FRC7732
FRC8392

FRC8387
FTC3705

TVB000150

571973

FRC8387

FTC3705

FTC4141

FTC5066

FTC5430



H: Hasta el año correspondiente. D: Desde el año correspondiente

GRUPO 21 : TRANSMISION



RODAMIENTOS DE RUEDAS DELANTERAS Y TRASERAS

REF

DEFENDER <i>DELANTEROS Y TRASEROS</i>	RTC3429
RANGE ROVER <i>DELANTEROS Y TRASEROS</i>	RTC3429
DISCOVERY <i>DELANTEROS Y TRASEROS</i>	RTC3429
NEW RANGE <i>DELANTERO LADO DERECHO</i>	FTC3226
NEW RANGE <i>DELANTERO LADO IZQUIERDO</i>	FTC3243
NEW RANGE <i>TRASEROS</i>	FTC3223
FREELANDER	ANR5861

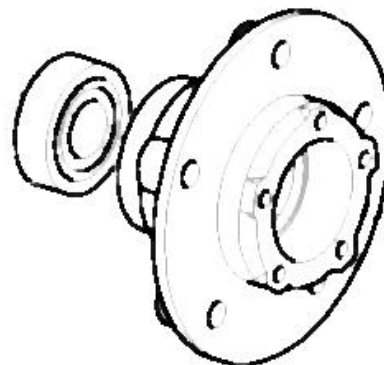

RETENES DE DIFERENCIAL

REF

DEFENDER 90/110 <i>DELANTEROS</i>	FRC8220
DEFENDER 110 <i>TRASEROS</i>	AEU2515
DEFENDER 90 <i>TRASEROS</i>	FRC8220
RANGE ROVER H: 1985	FRC4586
RANGE ROVER D: 1985	FRC8220
DISCOVERY	FRC8220
NEW RANGE	STC3124
FREELANDER <i>TRASEROS</i>	FTC5258

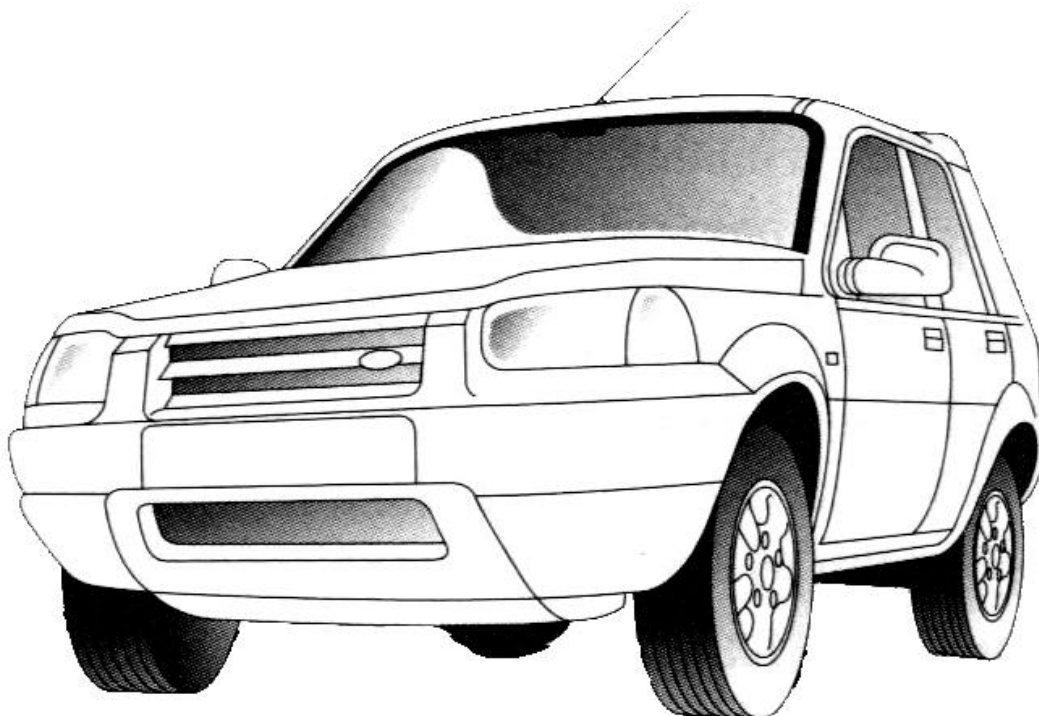

H: Hasta el año correspondiente. D: Desde el año correspondiente

IDENTIFICACIÓN DE LA NÚMERACIÓN DE CHASIS DE LOS VEHÍCULOS LAND ROVER.

3 LETRAS	2 LETRAS	1 LETRA	1 LETRA
SAL	LH	A	M
SAL: LAND ROVER LTD.	LH: RANGE ROVER LB: SERIE III LD: 90 o 110 LJ: DISCOVERY LP: NEW RANGE LT: DISCOVERY II LN: FREELANDER	A: RANGE 100" o LAND ROVER 88" C: LAND ROVER 109" H: LAND ROVER 110" M: VEHÍCULO ESPECIAL V: LAND ROVER 90" G: DISCOVERY 100" B: RANGE ROVER CLASSIC 108"	M: 4 PUERTAS STATION WAGON (109, 110, RANGE ROVER, DISCOVERY) A: CABINA CAJA, CABINA TOLDO, CAMIONETA O TECHO DURO. B: 2 PUERTAS STATION WAGON 88, 90, RANGE ROVER, DISCOVERY. H: PICK UP ALTA CAPACIDAD. R: RANGE ROVER "MONTEVERDI".
1 LETRA	1 NÚMERO	1 LETRA	1 LETRA
V	2	A	A
V: V8 3.5L CARB. H: 2.25L GASOLINA G: 2.25L DIESEL C: 2.5L DIESEL D: 2.5L GASOLINA E: 2.4L VM DIESEL F: 2.5L TDI DIESEL L: 3.5L GASOLINA INYECCIÓN M: 3.9L & 4.0L GASOLINA INYECCIÓN N: 2.5 VM DIESEL B: 2.5L DIESEL TURBO J: 4.6L GASOLINA INYECCIÓN W: 2.5L BMW DIESEL TURBO 8: 2.5 TD5 A: 1800cc B: 2000 T.CIE G/H/J: V6 E: TD4	1: 4 VELOCIDADES CONDUCCIÓN DERECHA 2: 4 VELOCIDADES CONDUCCIÓN IZQUIERDA 3: AUTOMÁTICO CONDUCCIÓN DERECHA 4: AUTOMÁTICO CONDUCCIÓN IZQUIERDA 5: 4 VELOCIDADES + SUPERMARCHA CONDUCCIÓN DERECHA 6: 4 VELOCIDADES + SUPERMARCHA CONDUCCIÓN IZQUIERDA 7: 5 VELOCIDADES CONDUCCIÓN DERECHA 8: 5 VELOCIDADES CONDUCCIÓN IZQUIERDA	A: TODOS LOS MODELOS EXCEPTO: B: SERIE III, CSW, RANGE FASE II, 90, 110 RESTLYNG HASTA 1987. C: RANGE ROVER 1986 MODELO/AÑO D: RANGE ROVER 1987 MODELO/AÑO E: 1988 MODELO AÑO F: 1989 MODELO/AÑO G: 1990 MODELO/AÑO H: 1991 MODELO/AÑO J: 1992 MODELO/AÑO K: 1993 MODELO/AÑO L: 1994 MODELO/AÑO M: 1995 MODELO/AÑO T: 1996 MODELO/AÑO V: 1997 MODELO/AÑO W: 1998 MODELO/AÑO X: 1999 MODELO/AÑO Y: 2000 MODELO/AÑO 1: 2001 MODELO/AÑO 2: 2002 MODELO/AÑO	A: FABRICADO EN SOLIHULL B: CKD

ACEITES

DEFENDER 90/110

MOTOR DE GASOLINA	10W40 ó 15W40
MOTOR DIESEL	10W40 ó 15W40
CAJA DE CAMBIOS DE 5 VELOCIDADES	ATF DEXRON IID
CAJA DE TRANSFERENCIAS	EP90 GEAR OIL
DIRECCION ASISTIDA	ATF DEXRON IID
DIRECCION MANUAL	EP90 GEAR OIL
EJES	EP90 GEAR OIL
PIVOTES DE DIRECCION	EP90 GEAR OIL



RANGE ROVER CLASSIC

MOTOR DE GASOLINA	10W40 ó 15W40
MOTOR TDI	15W40
MOTOR VM	15W40
CAJA DE CAMBIOS MANUAL	
LT380	ATF DEXRON IID
LT77	ATF M2C33G
LT95	15W40
CAJA DE TRANSFERENCIAS:	
LT230	EP90
BORG WARNER	ATF DEXRON IID
LT95	15W40
DIRECCION ASISTIDA	ATF DEXRON II ó ATF TIPO "G"
EJES	EP90



DISCOVERY

MOTOR DE GASOLINA	10W40 ó 15W40
MOTOR DIESEL	10W40 ó 15W40
CAJA DE CAMBIOS MANUAL	ATF DEXRON IID
CAJA DE CAMBIOS AUTOMATICA	ATF DEXRON IID
CAJA DE TRANSFERENCIAS	EP90
DIRECCION ASISTIDA	ATF DEXRON IID
DIRECCION MANUAL	EP90
EJES	EP90
PIVOTES DE DIRECCION	EP90



Polígono Industrial Urtinsa II.
Calle Navales, Nave 31.
28925 - Alcorcón - Madrid - España
Tlfs. 916433655 - 916434332
Fax. 916439407
E-mail. angloreCambis@ctv.es

